

Article number: 20286B42B48T2SW

Description: E+G Swivel clamp connector joint  
GN286-B42-B48-T-2-SW

## Measures

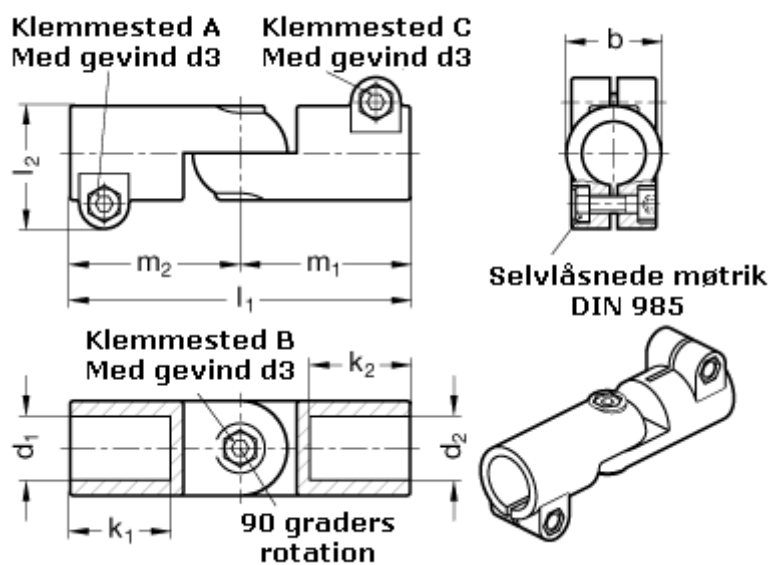

$b = 65$	$m_1 = 115$
$d_1 = B42$	$m_2 = 115$
$d_2 = B48$	
$d_3 = M10$	
$k_1 = 74.0$	
$k_2 = 74.0$	
$l_1 = 230$	
$l_2 = 77.5$	